



THE GENERAL RADIO

Experimenter

IMPROVED **GR874** SLOTTED LINE
PRECISION COAXIAL TUNERS
TE₁₁-MODE RESONANCE
IN TYPE **900-BT**
CONNECTOR

HIGH-RESOLUTION
WAVE-ANALYSIS RECORDING
NEW DECADE CAPACITOR
10-pF REFERENCE STANDARD

VOLUME 40 · NUMBER 8 / AUGUST 1966

the Experimenter

© 1966 — General Radio Company, West Concord, Mass., USA

Published monthly by the General Radio Company

THIS ISSUE

	Page
The Improved GR874 Slotted Line.....	3
Impedance-Matching Tuners for Precision Coaxial-Measuring Systems...	6
TE ₁₁ -Mode Resonances in Precision Coaxial Connectors.....	10
New Decade Capacitor—Wide Range, High Resolution.....	14
A 10-pF Reference Standard Capacitor.....	17
Increased Frequency Resolution for Wave-Analyzer Recordings of Vibration, Acoustic, and Electrical Signals.....	18
Locating Submarine Cables.....	21

GENERAL RADIO COMPANY

West Concord, Massachusetts 01781

* **NEW ENGLAND**
 22 Baker Avenue
 West Concord, Massachusetts 01781

* **METROPOLITAN NEW YORK**
 Broad Avenue at Linden
 Ridgefield, New Jersey 07657

PHILADELPHIA
 Fort Washington Industrial Park
 Fort Washington, Pennsylvania 19034

* **WASHINGTON and BALTIMORE**
 11420 Rockville Pike
 Rockville, Maryland 20852

ORLANDO
 113 East Colonial Drive
 Orlando, Florida 32801

SYRACUSE
 Pickard Building, East Molloy Rd.
 Syracuse, New York 13211

CLEVELAND
 5579 Pearl Road
 Cleveland, Ohio 44129

* **CHICAGO**
 6605 West North Avenue
 Oak Park, Illinois 60302

* **DALLAS**
 2600 Stemmons Freeway, Suite 210
 Dallas, Texas 75207

* **LOS ANGELES**
 1000 North Seward Street
 Los Angeles, California 90038

SAN FRANCISCO
 626 San Antonio Road
 Mountain View, California 94040

* **TORONTO**
 99 Floral Parkway
 Toronto 15, Ontario, Canada

MONTREAL
 1255 Laird Boulevard
 Town of Mt. Royal, Quebec, Canada

* Repair services are available at these offices

GENERAL RADIO COMPANY (OVERSEAS), 8008 Zurich, Switzerland

GENERAL RADIO COMPANY (U.K.) LIMITED, Bourne End, Buckinghamshire, England

REPRESENTATIVES IN PRINCIPAL OVERSEAS COUNTRIES

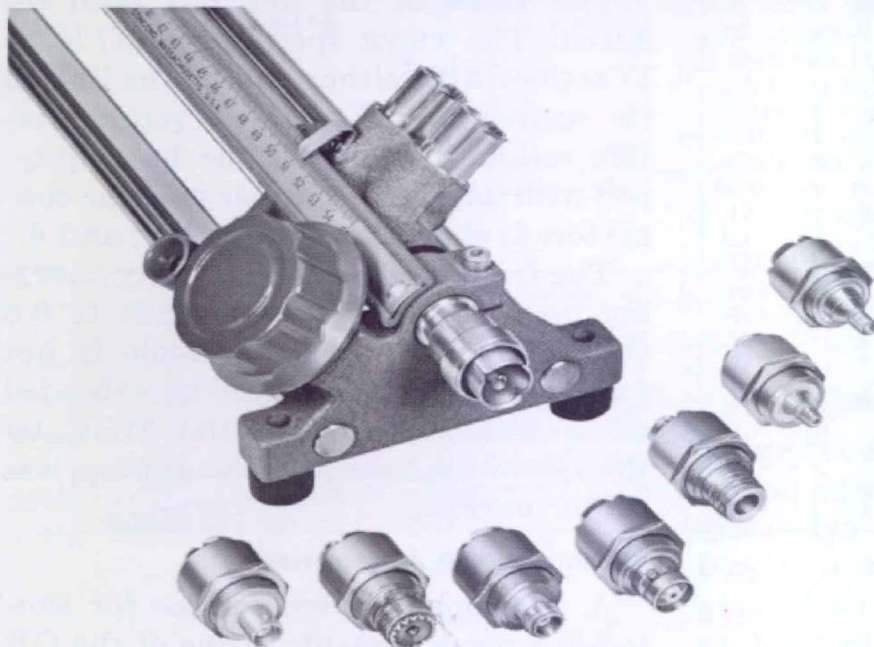

THE IMPROVED GR874 SLOTTED LINE

The slotted line is the traditional workhorse of the microwave measurement industry. It can be used to measure a great number of parameters, over an extremely broad band of frequencies and with good accuracy. The slotted line has its own internal impedance reference, an accurately constructed coaxial line, which is essentially free from aging effects. It is used to measure v_{SWR} , reflection coefficients, transmission coefficients, impedance, and admittance (resistance, inductance, and capacitance) of both passive and active networks (diodes, tubes, transistors); electrical length of two-ports; phase delay; insertion loss or attenuation of networks, cables for example; and dielectric constants of materials. It can

also be used as a precision phase shifter and as a wavemeter.

The slotted line can also be employed for accurate sweep-frequency measurements of v_{SWR} ¹, performing the function of a reflectometer over a wide frequency range.

GR manufactures two slotted lines, one based on the GR874 connector, the other on the GR900 precision connector. The GR874 line, while not so accurate as the precision type, is satisfactory for most everyday measurements, and thousands are now in use throughout the world. It is particularly well suited to the student laboratory, where its modest price is a boon to the budget.

The GR874 Slotted Line has recently been redesigned to reduce the residual v_{SWR} , to increase the high-frequency range, and to improve the constancy of probe coupling. The model number has been changed to TYPE 874-LBB. Over

¹ R. H. Behle, L. J. Smith, "Studies of Cold-Test Procedures Used in the Development of the L-4061 Crossed Field Amplifier," BTL Internal Report, No MM-63-2843-7, p 9; Bell Telephone Laboratories, Laureldale, Pa.



John Zorzy received his B.S. in Physics from George Washington University in 1948 and his M.S. from Tufts College in 1950. From 1950 to 1960 he was engaged in the design and development of radar, antennas, and microwave devices at Trans-Sonics, Hughes Aircraft, Avco, and Raytheon. He is a member of IEEE, Sigma Xi, Sigma Pi Sigma, and a member of the Precision Connector Subcommittee of IEEE and Committee JS-9 of JEDEC. He joined the Development Engineering Staff at GR in 1963 and is Section Leader in the Microwave Group.

the past several years many mechanical improvements have also been incorporated, and, recently, an externally adjustable probe tuner has been offered as an accessory. The improved locking connector, TYPE 874-BBL, is used at both ends of the slotted line.

These improvements result in an extremely versatile instrument with more than adequate performance for a general-purpose line. This line can be converted to use any of the popular UG connectors in a matter of seconds, through a TYPE 874-Q low-VSWR adaptor. These adaptors are available, both plug and jack types, for Types BNC, C, HN, LC, LT, Microdot, N, OSM, SC, TNC,

$\frac{1}{8}$ "-UHF line, GR900, and Amphenol 7-mm Precision Connectors.

Performance

The VSWR of the line has been reduced. The VSWR specification (Figure 1) applies with either end of the line as the source end. A series of representative residual VSWR's of the line equipped with adaptors to other popular connectors is shown in Figures 2, 3, and 4.

The frequency range, formerly covering up to 5 GHz, now extends to 8.5 GHz. The low-frequency limit is not fixed at 300 MHz; it can be extended downward, typically to 150 MHz, by the use of air lines and the appropriate probe tuner.

Recommended Accessories

A convenient power source for slotted-line measurements is one of the GR Unit oscillators, which are available in several models and offer a wide choice of frequency range and power supply. The detector can be a conventional standing-wave indicator or one of the GR TYPE DNT Heterodyne Detectors.

Probe tuning can be accomplished with the TYPE 900-DP Probe Tuner or, if the convenience of external probe-depth adjustment is not needed, with a TYPE 874-D20L or -D50L Stub.

A complete measuring assembly, consisting of the improved slotted line, a Unit high-frequency oscillator with power supply, and a Type DNT Detector.

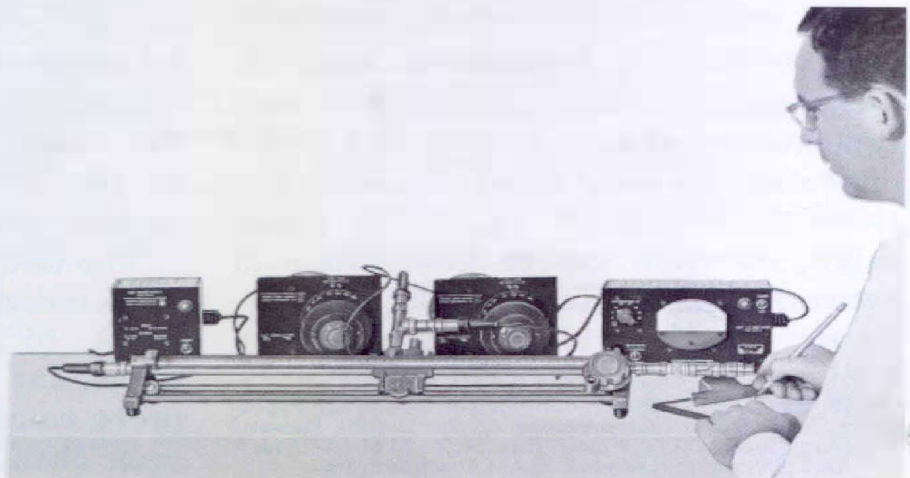

Figure 1. Type 874-LBB VSWR.

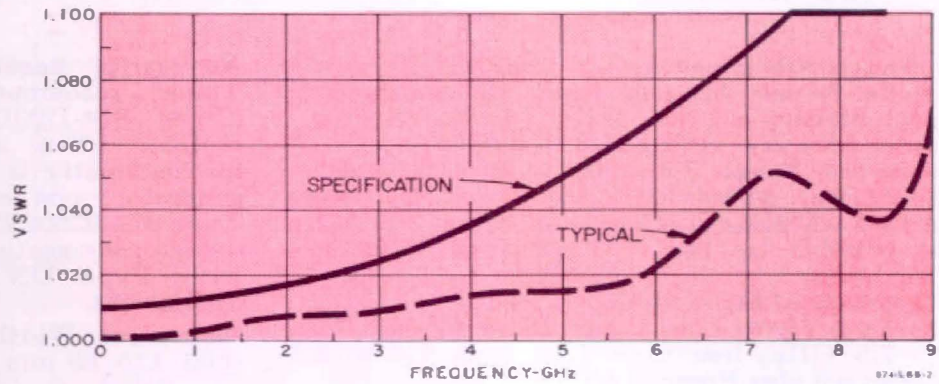

Figure 2.

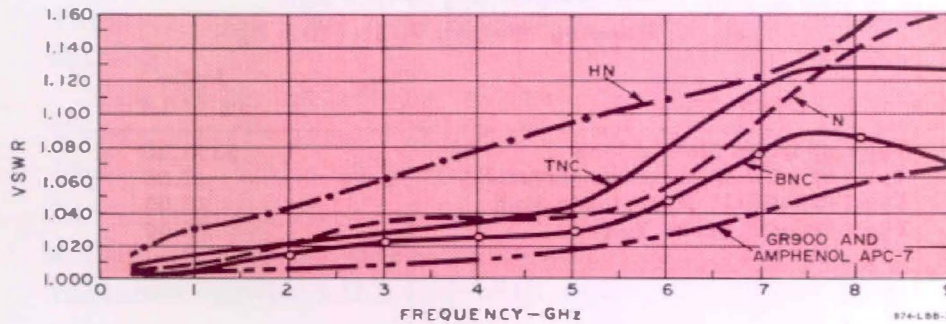

Figure 3.

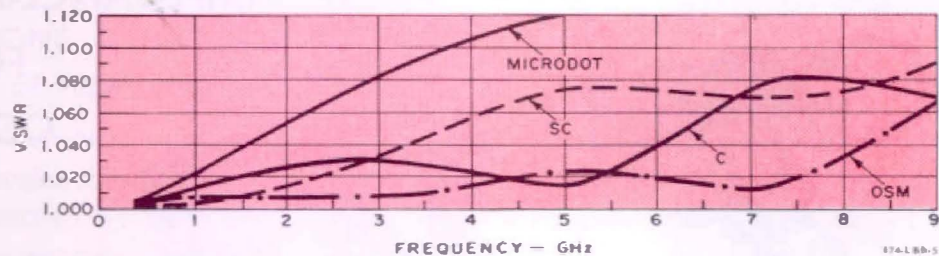
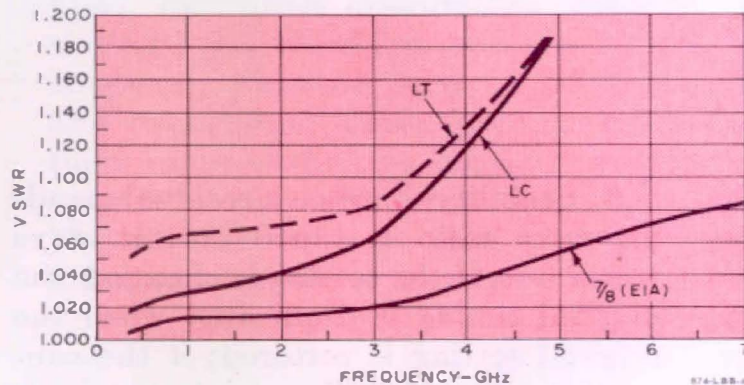

Figure 4.



Figures 2, 3 and 4. Representative residual VSWR of the Type 874-LBB equipped with adaptors to other coaxial connector types.

Other useful accessories: the TYPE 874-LV Micrometer Vernier, which allows a precise adjustment of probe-carriage position and is particularly useful in the width-of-minimum method of vswr measurement and in electrical length measurements; the TYPE 874-ML Component Mount for measurements on lumped elements.

Last, but by no means least in importance, are the TYPE 874-Q Adaptors mentioned above*. With the TYPE 874-LBB Slotted Line and a complete set of these adaptors, the equivalent of 23 slotted lines can be obtained at a total price of \$771.25.

J. ZORZY

* See the GR catalog or ask for a complete listing.

SPECIFICATIONS

Characteristic Impedance: 50 Ω ±0.5%.
Probe Travel: 50 cm. Scale in centimeters; each division is 1 mm.
Scale Accuracy: ±(0.1 mm + 0.05%).
Frequency Range: 300 MHz to 8.5 GHz (usable to 9 GHz). At 300 MHz, the slotted line covers a half wavelength. Operation below 300 MHz is possible by use of lengths of TYPE 874 Air Lines.
Constancy of Probe Pickup: ±1.25%.
Residual VSWR: Less than 1.01 + 0.0016 f²GHz to 7.5 GHz; less than 1.10 from 7.5 to 8.5 GHz; see also Figure 1.
Accessories Supplied: Storage box, rf probe, and 2 microwave diodes.

Accessories Required: TYPE 900-DP Probe Tuner, recommended, or Adjustable Stub (TYPE 874-D20L) for tuning the crystal rectifier when audio-frequency detector or microammeter is used; suitable detector and generator; one each, TYPE 874-R22LA and TYPE 874-R22A Patch Cords, for generator and detector connections (patch cords are supplied with Type DNT Detector and GR Unit oscillators).

Dimensions: Width 26, height 4½, depth 3½ in (660, 115, 89 mm).

Net Weight: 8½ lb (3.9 kg).

Shipping Weight: 23 lb (10.5 kg).

Catalog Number	Description	Price in USA
0874-9651	Type 874-LBB Slotted Line	\$395.00
0874-9652	Type 874-LV Micrometer Vernier	41.00
0874-9511	Type 874-D20L Adjustable Stub	20.00
0900-9654	Type 900-DP Probe Tuner	75.00

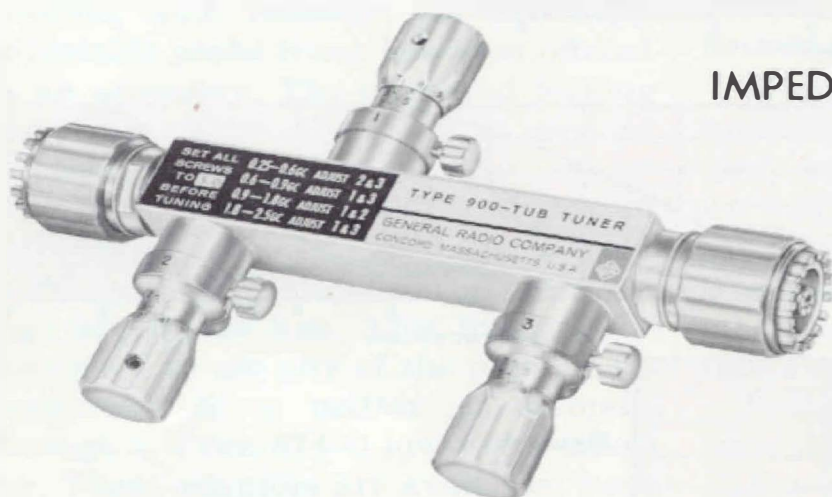

IMPEDANCE-MATCHING TUNERS FOR PRECISION COAXIAL-MEASURING SYSTEMS

The TYPE 900-TUB Tuner, for the 0.25- to 2.5-GHz frequency range, complements the previously announced TYPE 900-TUA Tuner¹, which covers the 1- to 8.5-GHz frequency range. The two tuners are similar in design and construction and, in addition to their wide bandwidths, have the following desirable features:

1. A unique neutral position, from which rapid convergence to match can always be achieved
2. A fineness of control, so that VSWR's as low as 1.0002 can be tuned out with ease

3. Stability — when a residual standing-wave ratio is tuned out, it stays tuned out; if the setting is changed, the original tuning is duplicated when the original setting is restored; if the connection between line and tuner is broken and then restored, the tuning is unchanged.

Each tuner has three tuning screws. In operation, two of the three screws are adjusted for match (which two depends on the frequency), while the unused screw is set to the neutral posi-

¹"Coaxial Tuner with Neutral Setting," *General Radio Experimenter*, January 1965.

Figure 1. VSWR matching range of the Types 900-TUB and -TUA Tuners. Specifications and data shown are under the most restrictive phase conditions of the reflection to be matched out.

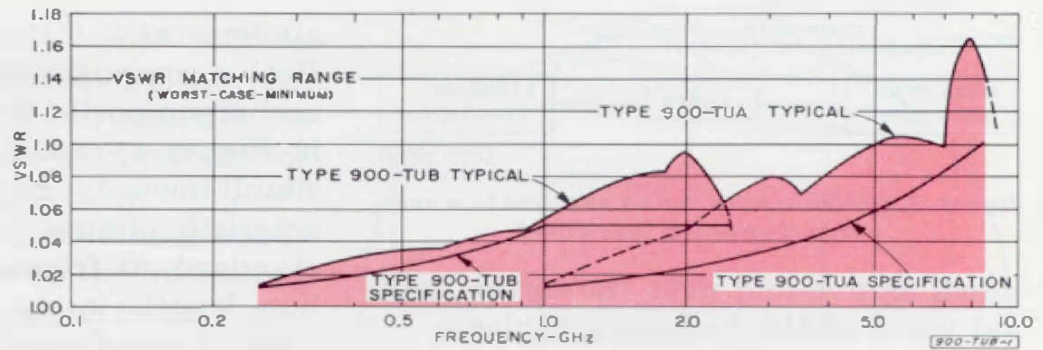

tion. Each screw has a scale, with vernier, and can be locked at any setting.

The vswr matching ranges of the TYPES 900-TUB and -TUA Tuners (see Figure 1), while they are high enough for most applications, have been kept sufficiently low that extremely fine matches can be achieved with ease and speed.

APPLICATIONS

Matching to a Standard of Impedance

With the GR900 Tuners one can reduce the residual reflections introduced into a coaxial system by terminations, measuring instruments (such as slotted lines, rf bridges and directional couplers), adaptors between line sizes, and connectors. These residual reflections must always be considered with respect to some standard of impedance. The standard may be part of a measuring instrument, it may be a termina-

tion, or it may be a section of precision air line. The tuner is used, therefore, to match the impedance of the device in question to that of the standard.

The Measuring Instrument as an Impedance Standard

The TYPE 900-LB Precision Slotted Line is an excellent impedance standard. It covers the 0.3- to 8.5-GHz frequency range, and, at 2 GHz, for example, the residual impedance error (expressed in vswr) is less than 1.003. If a composite termination consisting of a TYPE 900-W50 Standard Termination and a TYPE 900-TUA or -TUB Tuner is assembled, as shown in Figure 2, and the tuner is adjusted so that the amplitude of the standing-wave pattern observed on the slotted line is reduced to zero, then the residual vswr of the composite termination is made equal to the residual vswr of the slotted line. The improvement in vswr can be as

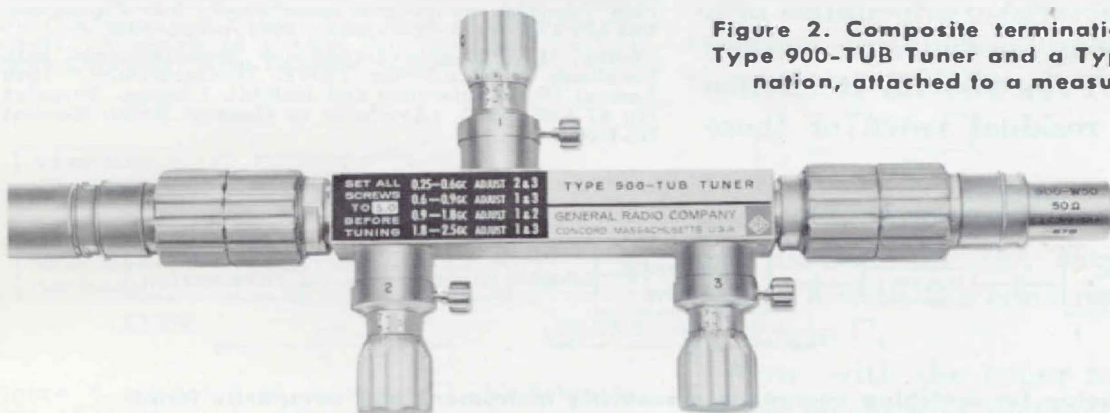

Figure 2. Composite termination consisting of a Type 900-TUB Tuner and a Type 900-W50 Termination, attached to a measuring instrument.

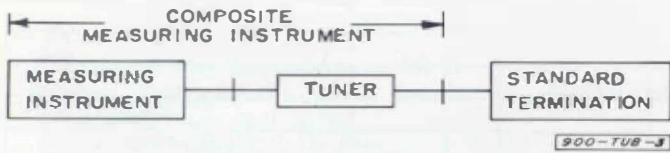

Figure 3. Standard termination attached to a composite measuring instrument.

much as five-fold over the direct residual VSWR of the termination alone.

Termination as an Impedance Standard

A well-matched termination, such as the TYPE 900-W50 Standard Termination or, even better, the composite termination described above, can also be used as an impedance standard. For example, if the measuring instrument is a directional coupler or a hybrid junction, the instrument residual may be much greater than that of an available standard termination. In these cases a composite measuring instrument, consisting of the basic measuring instrument and a TYPE 900-TUA or -TUB Tuner, can be formed, as shown in Figure 3, and the tuner adjusted so that a null is observed with the measuring instrument. The residual VSWR of the composite instrument is thus made equal to that of the standard termination.

Air Line as an Impedance Standard

The most accurate impedance standard is the characteristic impedance of a section of precision air-dielectric coaxial line, such as a TYPE 900-LZ Reference Air Line. The residual VSWR of these

air lines at 2 GHz is less than 1.0009. Both a composite measuring instrument and a composite termination, as shown in Figure 4, can be independently and simultaneously matched to the characteristic impedance of the air-line standard, at frequencies where the air-line length is an odd multiple of a quarter wavelength². The matching is accomplished by alternate adjustment of the tuners, I and II, until no reflection is observed by the measuring instrument (1) when the composite termination is connected through the air-line standard to the composite measuring instrument and (2) when the composite termination is connected directly to the composite measuring instrument (that is, with the air line out of the system).

Simplifying Substitution Measurements

Substitution techniques, such as those described by Sanderson³ and Zorzy⁴, are used to obtain accurate measurements of small reflections in the presence of comparable residual reflec-

² MacKenzie, Thomas E., "Some Techniques and Their Limitations as Related to the Measurements of Small Reflections in Precision Coaxial Transmission Lines," presented at the 1966 Conference on Precision Electromagnetic Measurements, June 21-24, NBS, Boulder, Colorado. (Publication scheduled in the *IEEE Transactions on Instrumentation and Measurement*, December 1966.)

³ Sanderson, A. E., "A New High-Precision Method for the Measurement of the VSWR of Coaxial Connectors," *IRE Transactions on Microwave Theory and Techniques*, Vol MTT-9, No 6, November, 1961, p 524-528.

⁴ Zorzy, J., "Precise Impedance Measurements with Emphasis on Connector VSWR Measurements," 18th Annual ISA Conference and Exhibit, Chicago. Preprint No 47.4.63, 1963. (Available as General Radio Reprint No B20.)

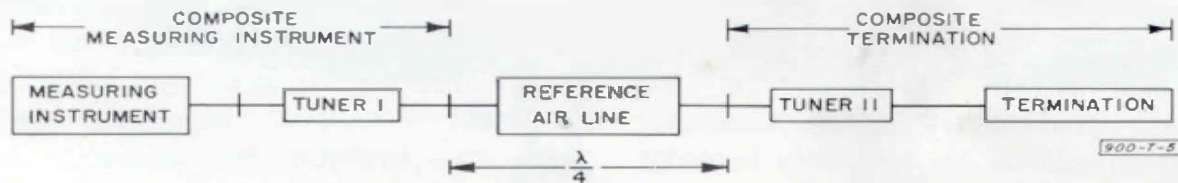

Figure 4. Setup for matching composite measuring instrument and composite termination to the characteristic impedance of an air-line standard.

tions in the measuring systems. In these techniques, two measurements are required, and the desired quantity is dependent on the vector difference of the two measured quantities.

When an impedance-matching tuner is used to make one of the measured reflection coefficients equal to zero, the second measurement alone provides the answer^{2,5}. This means that it is not necessary for one to perform the vector subtraction or to plot measurements on a Smith Chart and to make tedious constructions. Also, if only the magnitude of the answer is required, it can be obtained directly from just one magnitude measurement.

Quarter-Wavelength Substitution to Measure Termination

The simplification resulting from the use of the tuner is illustrated by the example of the substitution technique that employs a quarter-wavelength reference air line to determine the reflection of a termination in the presence of the residual reflection of the measuring instrument.

Without the tuner, two measurements are required, one with and one without the reference air line in the

² *Ibid.*
⁵ Sanderson, A. E., "Calibration Techniques for One- and Two-Port Devices Using Coaxial Reference Air Lines as Absolute Impedance Standards," *19th Annual ISA Conference and Exhibit*, New York, Reprint No. 21, 6-8-64. (Available as Reprint No B21 from General Radio Company, West Concord, Massachusetts.)

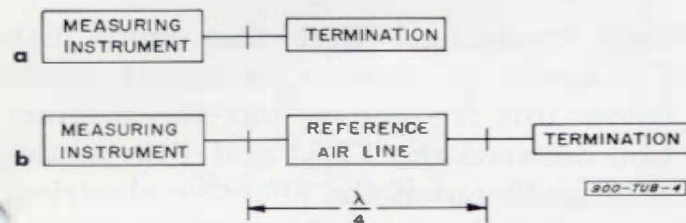

Figure 5. a) Setup to measure Γ_1 . b) Setup to measure Γ_2 .

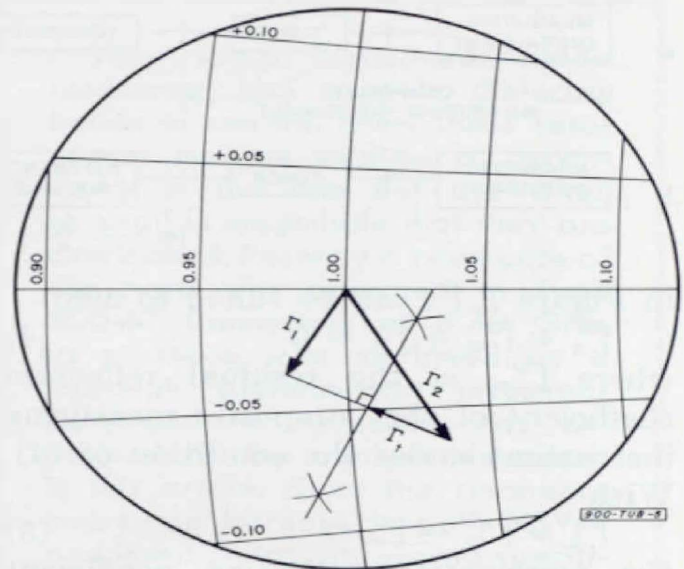

Figure 6. Smith Chart construction to determine Γ_t .

system, as illustrated in Figure 5. (It is assumed that the reference air line is reflectionless and lossless and that the reflection coefficients of interest are small.) Thus

$$\Gamma_1 = \Gamma_m + \Gamma_t \quad (1)$$

$$\Gamma_2 = \Gamma_m + \Gamma_t e^{-j\pi} = \Gamma_m - \Gamma_t \quad (2)$$

where

Γ_1 is the measured reflection coefficient without the reference air line inserted,

Γ_2 is the measured reflection coefficient with the reference air line inserted,

Γ_t is the reflection coefficient of the termination, and

Γ_m is the residual reflection coefficient of the measuring instrument.

The termination reflection coefficient is given from the difference of equations (1) and (2) by the vector relation

$$\Gamma_t = \frac{\Gamma_1 - \Gamma_2}{2} \quad (3)$$

The reflection coefficients Γ_1 and Γ_2 are plotted on the Smith Chart of Figure 6 with the construction required to obtain Γ_t .

Now, with the tuner forming a composite measuring instrument as shown

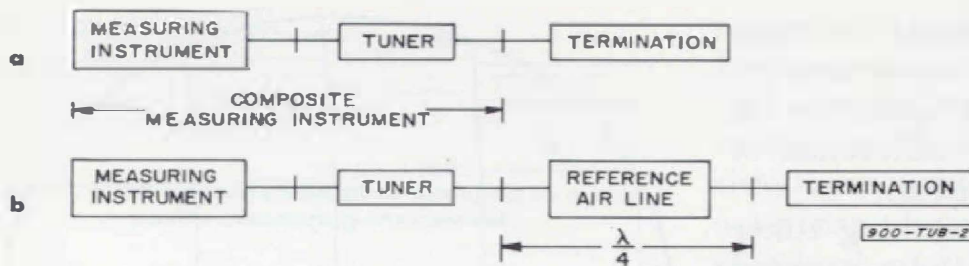

Figure 7. a) Setup to adjust Γ_1 to zero. b) Setup to measure Γ_2 and to determine Γ_1 directly.

in Figure 7, Γ_1 can be tuned to zero.

$$\Gamma_1 = \Gamma'_m + \Gamma_t = 0 \quad (4)$$

where Γ'_m is the residual reflection coefficient of the composite measuring instrument under the condition of (4).

With

$$\Gamma_2 = \Gamma'_m - \Gamma_t, \quad (5)$$

the termination reflection coefficient is given directly by

$$\Gamma_t = -\frac{\Gamma_2}{2}. \quad (6)$$

No vector subtraction, and therefore no constructions on the Smith Chart, is required.

Similar simplifications can be realized in other substitution techniques through the application of the TYPES 900-TUA and -TUB Tuners.

— T. E. MACKENZIE

Note: A brief biography of Thomas E. MacKenzie, author of the foregoing article, appeared in the May 1966 issue of the *Experimenter*. — Editor

SPECIFICATIONS

	900-TUA	900-TUB
Frequency Range	1 to 8.5 GHz	0.25 to 2.5 GHz
Characteristic Impedance	50 Ω	50 Ω
VSWR Matching Range (worst-case minimum)*	$1.00 + 0.012 f_{\text{GHz}}$	$1.00 + 0.05 f_{\text{GHz}}$ to 1 GHz 1.05 from 1 to 2.5 GHz
VSWR Resetability	$< 1.0005 + 0.0003 f_{\text{GHz}}$	$< 1.0005 + 0.0003 f_{\text{GHz}}$
Residual VSWR (all controls at neutral)	< 1.03 to 5 GHz < 1.05 from 5 to 7 GHz	< 1.03 to 1.5 GHz
Insertion Loss	< 0.1 dB to 4 GHz < 0.3 dB to 8.5 GHz	< 0.1 dB
Repeatability of Connection	0.05%	0.05%
Electrical Length	12.0 cm	18.5 cm
Dimensions	$4\frac{1}{2} \times 3\frac{1}{2} \times 1$ in (115, 88, 25 mm)	$6\frac{1}{2} \times 4\frac{3}{4} \times 1$ in (165, 120, 25 mm)
Net Weight	1 lb (0.5 kg)	$1\frac{1}{4}$ lb (0.6 kg)
Shipping Weight	3 lb (1.4 kg)	4 lb (1.9 kg)
Catalog Number	0900-9635	0900-9637

* Range is wider under most conditions

TE₁₁-MODE RESONANCES IN PRECISION COAXIAL CONNECTORS

It has been common practice to specify the upper frequency limit of a precision coaxial system as the calculated frequency at which the next higher mode above the TEM mode (TE₁₁) could propagate in the air-dielectric section of the line. It has, of course,

been recognized that this mode can propagate in dielectric support beads below this frequency, but the interaction between the TEM and TE₁₁ modes is insignificant if the effective electrical length of the bead is so short that a TE₁₁-mode resonance does not occur.

However, the effective electrical length of the bead for the TE_{11} mode is increased by the reactive loads presented to the TE_{11} mode at each end of the bead by the air-dielectric line sections, which are below cutoff for this mode, and the resonant frequency may therefore occur at a lower frequency than would be predicted by simple theory.

In a coaxial system, either a single bead or a pair of beads that are separated by a short section of air-filled line can resonate. The TE_{11} -mode resonance can then cause an increase in both VSWR and insertion loss; if the beads are part of connectors, these increases can vary in magnitude as the relative connector orientation is changed. The effect of the resonance is noticeable over only a narrow frequency band. The TE_{11} mode may be initiated by asymmetries such as slots or probes, as in a slotted line, or by eccentricities or irregularities that may occur in transitions between lines of different sizes.

Calculations of resonant frequency can be made on an impedance basis through the use of conventional transmission-line equations. Best agreement between calculated and measured data is obtained, in the particular case investigated, when the short undercut lengths,[†] such as 1-2 (see Figure 1), are treated as sections of air-dielectric

Very sharp higher-order-mode resonances can exist in dielectric beads in coaxial lines. These resonances can be excited by asymmetry in the line but are often so small in magnitude that they are overlooked. Recently a resonance of this type was observed in Type 900-BT Connectors at 8.70 GHz, its presence was confirmed by a thorough experimental investigation, and its existence was explained by the analysis described in this article. Since the resonance causes an increase in both VSWR and insertion loss exceeding specifications, we have lowered the upper frequency specification for Type 900-BT Connectors to 8.5 GHz.

line. The condition for resonance of a single bead (Figure 1a) is that $Z_3 = Z_2^*$, where Z_2^* is the conjugate of Z_2 . The input impedance, Z_1 , to the air-dielectric line is given by

$$Z_1 = Z_0 \frac{Z_L + Z_0 \tanh \gamma l}{Z_0 + Z_L \tanh \gamma l} \quad (1)$$

where

Z_0 = characteristic impedance of air-dielectric line

Z_L = terminating impedance of air-dielectric line

[†] These undercuts compensate for the discontinuity introduced by the abrupt changes in the conductor diameters at the bead.

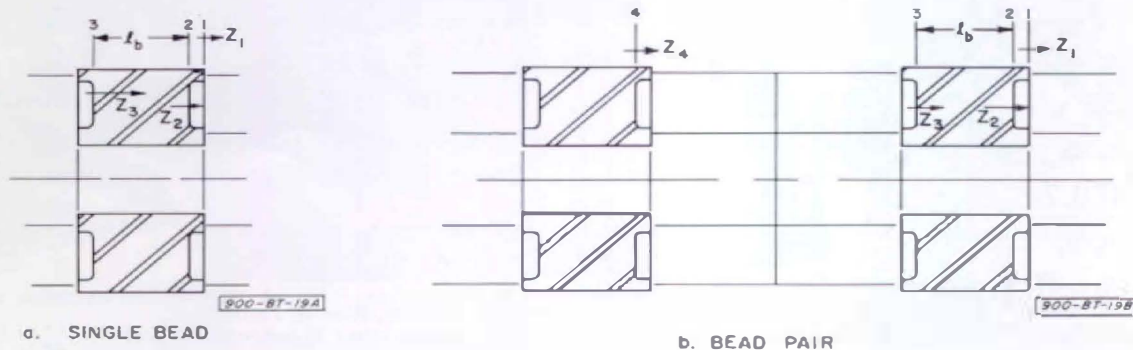

Figure 1. Cross-sections of GR900 dielectric support beads.

γ = propagation constant of air-filled line
 l = length of air-filled line.

For TE₁₁ mode:

$$Z_o = j\eta \frac{f}{f_c} \sqrt{1 - \left(\frac{f}{f_c}\right)^2} \text{ for } f < f_c \quad (2)$$

where

f_c = cutoff frequency for TE₁₁ mode in air-dielectric line
 $\eta = 376.7$.

And

$$\gamma = \frac{2\pi}{\lambda_c} \sqrt{1 - \left(\frac{f}{f_c}\right)^2} \quad (3)$$

where λ_c = cutoff wavelength for the mode in the line.

In most practical cases, the air-dielectric section of line is long enough so that $0.99 < \tanh \gamma l \leq 1.00$. Then

$$Z_1 \approx Z_o \frac{Z_L + Z_o}{Z_o + Z_L} = Z_o. \text{ Thus the}$$

input impedance, Z_1 , is an inductive reactance below the cutoff frequency of the air-dielectric line and is given by equation (2). The characteristic impedance and propagation constant in the bead are given by

$$Z_{o_b} = \frac{\eta_b}{\sqrt{1 - \left(\frac{f_c}{f}\right)^2}} \text{ for } f > f_c \quad (4)$$

$$\text{and } \gamma_b = jk \sqrt{1 - \left(\frac{f_c}{f}\right)^2} \quad (5)$$

where

$$k = \frac{2\pi \sqrt{\epsilon_r}}{\lambda}$$

$$\eta_b = \frac{376.7}{\sqrt{\epsilon_r}}$$

f_c = cutoff frequency for TE₁₁ mode in dielectric bead^{1,2}

ϵ_r = dielectric constant of bead.

If we treat region 1-2 as a section of air-dielectric line and let $Z_2 = Z_1$, the Z_3 can be calculated from

$$Z_3 = Z_{o_b} \frac{Z_2 + Z_{o_b} \tanh \gamma_b l_b}{Z_{o_b} + Z_2 \tanh \gamma_b l_b} \quad (6)$$

where l_b = length of bead.

One method of solving for f is to assume a value of f , solve for $Z_o (=Z_2)$ in equation (2), Z_{o_b} in equation (4) and γ_o in equation (5), and then find Z_3 from equation (6). At resonant frequency, $Z_3 = Z_2^*$.

The resonant frequency of the bead pair (Figure 1b) may be calculated in a similar manner. Two resonant frequencies exist, one below and one above the resonant frequency of a similar single bead. Determine Z_1 from equations (1) and (2), Z_3 from equation (6), and Z_4 from equation (1), using Z_3 for Z_L and calculating γ from equation (3). The short undercut regions are again treated as part of the air line. At the resonant frequencies, $Z_4 = Z_3^*$. The two resonant frequencies can be found by successive trials.

Calculations on this basis were made for the GR900 connector. This connector uses a Teflon[†] support bead, in which the TE₁₁-mode cutoff frequency^{1,2} is 7.03 GHz. The cutoff frequency in the adjacent air-dielectric line is 9.49 GHz. The bead is much shorter than a half wavelength (which might be expected to be the resonant length) for the TE₁₁ mode, even at 9 GHz, but the loading effect of the reactive impedance of the air-dielectric lines for this mode causes the reso-

[†] DuPont trademark

¹ J. Dimitrios, "Exact Cutoff Frequencies of Precision Coax," *MicroWaves*, June 1965.

² N. Marcuvitz, *Waveguide Handbook*, MIT Radiating Laboratory Series, Vol. 10, McGraw Hill, New York, 1951, p 77.

nance of a single bead at 8.86 GHz. Typically, the *v*swr increases by 0.10 at this frequency, and the insertion loss by 0.35 dB. A pair of beads spaced as in a Type 900-BT Connector pair exhibits a resonance at 8.70 GHz, as well as one above 9 GHz. Typically, the *v*swr increases by 0.03 at this frequency, and the insertion loss by 0.25 dB. The bandwidth over which either resonance is noticeable is approximately 60 MHz. The calculated resonant frequencies agreed with those measured within 1%. The higher resonant frequency of the bead pair was not investigated experimentally.

While such calculations are not completely rigorous (for example, the effect of the steps in inner and outer conductors are ignored), they do give useful results for this and other bead sizes. A field analysis was also used to predict the resonant frequencies, but the results did not agree with the experimental data as well as those obtained from the procedure described above.

The resonant frequencies can be raised by a decrease in the length of the bead. In the GR900 connector,

however, the mechanical stability and ruggedness would be impaired if the bead length were shortened by almost 1/3, the amount necessary to raise the resonant frequency of the connector pair by 300 MHz. In most applications, the resonance of the connector pair will go unnoticed. It escaped detection in the original development work on the connector, even in swept-frequency measurements on connector pairs, because its effect on *v*swr was both small and dependent upon orientation.

One should exercise caution when working near the upper frequency limit of any coaxial system. A sudden, sharp increase in *v*swr or variation in *v*swr as relative connector orientation is varied may indicate the presence of a TE_{11} -mode resonance. Unusual conditions, such as the presence of non-symmetrical devices or of large amounts of dielectric close to the connector dielectric support, can increase the effect of the resonance on the TEM mode or lower the resonant frequency.

John F. Gilmore

Note: A brief biography of John F. Gilmore, author of the foregoing article, appeared in the May 1966 issue of the *Experimenter*. — Editor

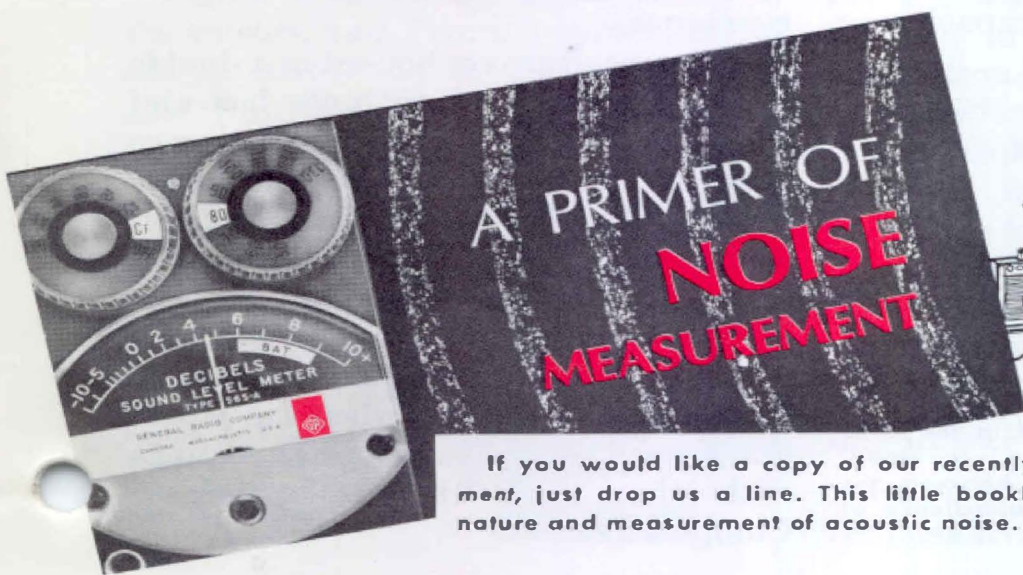

One man's noise is another man's music.

If you would like a copy of our recently published *Primer of Noise Measurement*, just drop us a line. This little booklet discusses with a light touch the nature and measurement of acoustic noise. Free.

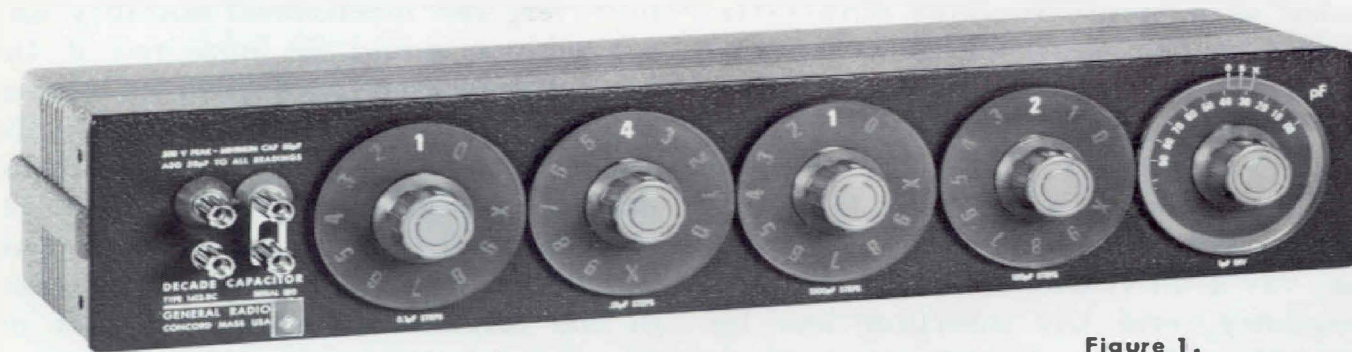

Figure 1.

NEW DECADE CAPACITOR — WIDE RANGE, HIGH RESOLUTION

The engineer who has occasion to use variable capacitors over a considerable frequency range will welcome the new TYPE 1412-BC Decade Capacitor. It has four polystyrene-dielectric decades, covering a range of 1.111 microfarads, as well as a continuously variable air capacitor, permitting very fine capacitance adjustment. In experimental circuits, it can be used not only at low frequencies where circuit capacitances are large but also, by virtue of its air capacitor and low internal inductance, at the lower radio frequencies.

The wide capacitance range and high resolution of this decade capacitance

box make it useful in both laboratory and test shop. Owing to its fine adjustability of capacitance, it is a convenient variable capacitor to use with the Type 1605-A Impedance Comparator.

Construction

Ceramic-insulated switches, with solid-silver-alloy contacts, select parallel combinations of capacitors having values in the ratio of 1:2:2:5. The capacitors are of extended foil construction for minimum inductance and low series resistance. Polystyrene dielectric is used for stability of capacitance, low dielectric losses, and high insulation resistance.

The capacitors are housed in a double shield, consisting of an inner box and the outside case, so that the difference between the capacitances for two-terminal and three-terminal connections is very small — only one picofarad, the capacitance (C_{HG}) of the binding post H to the case. It is particularly desirable that this capacitance be as small as possible when the capacitor is used at low capacitance settings with the Type 1605-A Impedance Comparator.

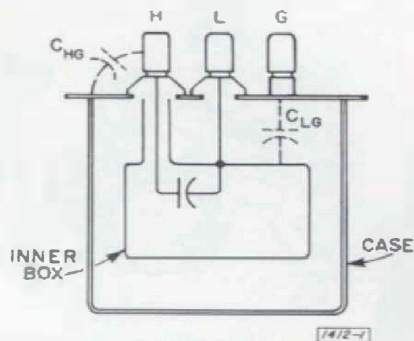

Figure 2. The double shielding used in the Type 1412-BC Decade Capacitor keeps C_{HG} very small. This capacitance is the difference between the three-terminal and two-terminal capacitance of the box; C_{LG} is approximately 125 pF.

Figure 3.



Figure 2 shows the arrangement of the shields, and Figure 3 typical methods of connection to the panel terminals. Hardware is supplied for installing the assembly in a standard rack, and

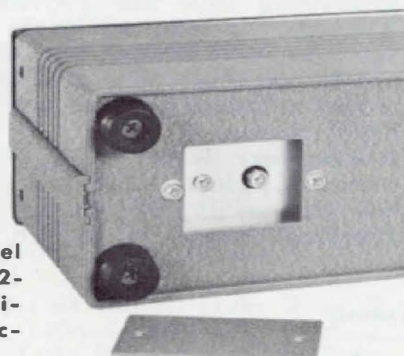

Figure 4. Rear panel view of Type 1412-BC, showing terminals for rear connections.

terminals are brought out at the rear for convenient connection (Figure 4).

Readout

The four decades have clear, easy-to-read dials with numbered steps from 0 to X (X = 10). The air-capacitor dial has ten 10-pF divisions, plus additional readout to 1 pF per graduation. To read the dial, simply add the number of graduations (counting from 0) on the fixed vernier scale to the corresponding numbered division on the dial. For an increase in capacitance, the knob turns clockwise and the small graduations read clockwise. Sample settings are illustrated in Figure 5.

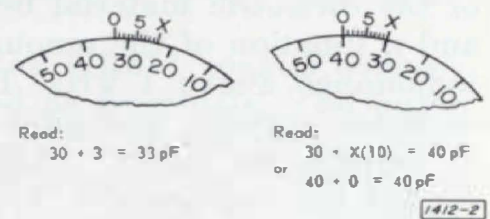

Figure 5.

Dissipation Factor

The dissipation factor of the polystyrene dielectric is quite low and relatively constant over the frequency range ordinarily encountered in most applications. At the extremes of the capacitance range, minor increases can be expected.

At the lower capacitance settings, the dissipation factor is increased by losses in the switch insulation and other materials outside the capacitors. The effect of these losses increases as the frequency is lowered.

At higher capacitance settings, the dissipation factor is increased by the series resistance of the wiring. This effect increases with frequency.

Capacitance

Capacitance changes with changes in frequency are principally a function



Robert W. Orr received his B.S. in E.E. from Texas A and M in 1928. After two years as a student engineer at General Electric Company, he held engineering and administrative posts in the field of capacitor engineering with RCA; Erie Resistor Corp; AMP, Inc.; and Aerovox Corp. He joined GR's Development Engineering Department in 1964. He is chairman of ASTM Committee D-9 on Electrical Insulating Materials, a member of Committee D-27 on Electrical Insulating Liquids and Gases, a member of the NRC Conference on Electrical Insulation, and a member of IEEE.

of the dielectric material below 1 kHz and a function of the amount of series inductance above 1 kHz. Polystyrene dielectric ensures negligible variations of capacitance below 1 kHz, and extended foil construction keeps the inductance of the capacitor itself low.

Most of the inductance is in the wiring. When the operating frequency (f) is well below the resonant frequency

(f_r), the approximate increase in effective capacitance (ΔC) over the zero-frequency capacitance (C_o) is given by the expression:

$$\frac{\Delta C}{C_o} \approx \left(\frac{f}{f_r}\right)^2$$

Typical values of the resonant frequency are:

Decade Capacitance	Resonant Frequency	
	Front Terminals	Rear Terminals
1.11115 μ F	430 kHz	310 kHz
1.0 μ F	440 kHz	320 kHz
0.1 μ F	1.25 MHz	1.2 MHz
0.01 μ F	3.5 MHz	4.3 MHz
1050 pF	10 MHz	17 MHz
150 pF	27 MHz	70 MHz

At frequencies up to 30 kHz, the effective capacitance at any setting will be less than 1% higher than the value of capacitance at 1 kHz. At most settings, the error will be much smaller.

— R. W. ORR

SPECIFICATIONS

Capacitance: 50 pF to 1.11115 μ F in steps of 100 pF with a 0- to 100-pF variable air capacitor providing continuous adjustment with 1-pF divisions. Capacitance for 2- and 3-terminal connections differs by about 1 pF.
Dielectric: Polystyrene for decade steps.
Accuracy: $\pm(1.0\% + 5 \text{ pF})$ at 1 kHz.
Temperature Coefficient: -140 ppm/ $^{\circ}$ C (nominal).

Frequency Characteristics: $\frac{C_{dc}}{C_{1kHz}} < 1.001$. At higher frequencies the increase is approximately $\Delta C/C = (f/f_r)^2$. See table above for typical values of f_r .

Maximum Operating Temperature: 65 $^{\circ}$ C.

Dielectric Absorption (Voltage Recovery): 0.1% maximum.

Dissipation Factor: 150 to 1000 pF, 0.001 max, at 1 kHz; over 1000 pF, 0.0002, max, at 1 kHz.

Insulation Resistance: 10^{12} ohms, minimum, at 500 V, dc.

Maximum Voltage: 500 V peak up to 35 kHz.

Terminals: Four Type 938 Binding Posts with grounding link are provided on the panel. Two of the binding posts are connected to the case and located for convenient use with patch cords in 3-terminal applications. Access is also provided to rear terminals for relay-rack applications.

Dimensions: Width 17 $\frac{5}{16}$, height 3 $\frac{1}{2}$, depth 6 inches (440, 89, 155 mm), over-all.

Net Weight: 8 $\frac{1}{2}$ lb (3.9 kg).

Shipping Weight: 10 lb (4.6 kg).

Catalog Number	Description
1412-9410	Type 1412-BC Decade Capacitor



A 10-pF REFERENCE STANDARD CAPACITOR

To supplement the highly stable TYPE 1404-A (1000 pF) and TYPE 1404-B (100 pF) Reference Standard Capacitors¹, we now have available a 10-pF model, the TYPE 1404-C.

Standard capacitors in the 1404 series are highly stable units, hermetically sealed in an inert gas, and closely adjusted to their nominal values.

All critical parts of the plate assembly are made of Invar for stability and low temperature coefficient. After heat cycling and adjustment, the assembly is mounted in a heavy brass container,

which, after evacuation, is filled with dry nitrogen under a pressure slightly above atmospheric and sealed. The container is mounted on an aluminum panel and protected by an outer aluminum case. Each capacitor is subjected to a series of temperature cycles to determine hysteresis and temperature coefficients and to stabilize the capacitance.

Two locking GR874 coaxial connectors are used as terminals. The outer shell of one is connected to the case, but the outer shell of the other is left unconnected to permit the capacitor to be used with an external resistor as a dissipation-factor standard.

¹John F. Hersh, "A Highly Stable Reference Standard Capacitor," *General Radio Experimenter*, August 1963.

SPECIFICATIONS

Calibration: A certificate of calibration is supplied with each capacitor, giving the measured direct capacitance at 1 kHz and at $23^\circ \pm 1^\circ\text{C}$. The measured value is obtained by a comparison to a precision better than ± 1 ppm with working standards whose absolute values are known to an accuracy of ± 20 ppm, determined and maintained in terms of reference standards periodically measured by the National Bureau of Standards.

Adjustment Accuracy: The capacitance is adjusted before calibration with an accuracy of ± 5 ppm to a capacitance about 5 ppm above the nominal value relative to the capacitance unit maintained by the General Radio reference standards.

Stability: Long-term drift is less than 20 parts per million per year. Maximum change with orientation is 10 ppm and is completely reversible.

Temperature Coefficient of Capacitance: 2 ± 2 ppm/ $^\circ\text{C}$ for TYPES 1404-A and -B, 5 ± 2 ppm/ $^\circ\text{C}$ for TYPE 1404-C, from -20°C to

Equivalent circuit showing direct capacitance, C_d , and average values of residual inductance, L , and terminal capacitances, C_a and C_b . $C_d = 1000$ pF for Type 1404-A, 100 pF for Type 1404-B, and 10 pF for Type 1404-C.

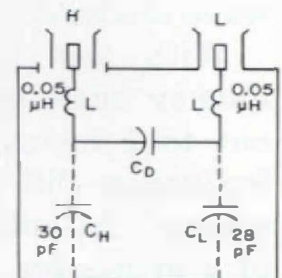

$+65^\circ\text{C}$. A measured value with an accuracy of ± 1 ppm/ $^\circ\text{C}$ is given on the certificate.

Temperature Cycling: For temperature cycling over range from -20°C to $+65^\circ\text{C}$, hysteresis (retraceable) is less than 20 ppm at 23°C .

Dissipation Factor: Less than 10^{-5} at 1 kHz.

Residual Impedances: See equivalent circuit for typical values of internal series inductances and terminal capacitances.

Maximum Voltage: 750 V.

Terminals: Two locking GR874 coaxial connectors; easily convertible to other types of connectors by attachment of locking adaptors. Outer shell of one connector is ungrounded to permit capacitor to be used with external resistor as a dissipation-factor standard.

Accessories Required: For connection to TYPE 1615-A Capacitance Bridge, 2 TYPE 874-R20A or TYPE 874-R22LA Patch Cords.

Dimensions: Width 6¾, height 6⅝, depth 8 in (175, 170, 205 mm), over-all.

Net Weight: 8½ lb (3.9 kg).

Shipping Weight: 14 lb (6.5 kg).

Catalog Number	Description
1404-9701	Type 1404-A Reference Standard Capacitor, 1000 pF
1404-9702	Type 1404-B Reference Standard Capacitor, 100 pF
1404-9703	Type 1404-C Reference Standard Capacitor, 10 pF

U.S. Patent Number 2,548,457.

INCREASED FREQUENCY RESOLUTION FOR WAVE-ANALYZER RECORDINGS OF VIBRATION, ACOUSTIC, AND ELECTRICAL SIGNALS

The TYPE 1900-A Wave Analyzer¹ is widely used for low-frequency spectrum analysis, because it has three bandwidths, 3, 10, and 50 Hz, and an 80-dB dynamic range for recording. The 3-Hz bandwidth is particularly popular, because of its excellent resolution. In order to take full advantage of that resolution, we are now making available a link unit that will permit recording with an expanded frequency scale on the TYPE 1521-B Graphic Level Recorder. This TYPE 1900-P3 Link Unit is shown in Figure 1 installed on the wave analyzer and recorder.

With this new link unit the frequency scale of a recording is spread out to 2 inches for 100 Hz, so that a frequency difference of 1 Hz can be noticed. An additional frequency scale of 2 inches for 1000 Hz, identical with that of the TYPE 1900-P1 Link Unit, is also provided. A neutral position simplifies the setting of the frequency control to the desired starting point.



Figure 1. Type 1900-P3 Link Unit installed on the wave analyzer and graphic level recorder.

The same chart paper, TYPE 1521-9464, is used for both speeds.

The recording reproduced in Figure 2 shows evidence of the smoothness of the frequency-control drive with this link unit. The components displayed are spaced 10 Hz apart in the vicinity of 50,000 Hz, and the absence of significant jitter in this expanded display demon-

¹ A. Peterson, "New Wave Analyzer has 3 Bandwidths, 80-dB Dynamic Range," *General Radio Experimenter*, April, 1964.

strates that the new drive can be used to advantage over the full frequency range of the wave analyzer. Of course, the applied signal must also be sufficiently stable that the 3-Hz bandwidth can be used. For the pulse signal analyzed in Figure 2, the pulse repetition frequency of a TYPE 1217-C Unit Pulse Generator was controlled at 10 Hz by a highly stable, crystal-controlled, time-mark generator so that the harmonics up to and beyond the 5000th would not show any appreciable jitter.

The resolution of the 3-Hz bandwidth and the convenient display of the analyzed spectrum on the recorder make the system well suited to the analysis of certain types of electrical, acoustic, and vibration signals, including for example, the acoustic noise and vibration produced by such rotating machinery as gear trains, electrical motors, and turbines.



Arnold P. G. Peterson received his B. Eng degree from the University of Toledo in 1934 and his S.M. and Sc.D. degrees from M.I.T. in 1937 and 1941, respectively. He was a research assistant at M.I.T. from 1936 to 1940. He came to General Radio in 1940 as a Development Engineer and became Group Leader of the Audio Group in 1947. He is a Fellow of IEEE and of the Acoustical Society of America, of which he was Vice President in 1958-59. He is a member of AAAS, AAPT, and AGU, and of several standards committees in the general field of acoustics.

Figures 3, 4, and 5 illustrate the detail that can now be obtained in a practical case. These recordings are analyses of the vibration of the paper-drive frame of the TYPE 1520-A Sampling Recorder. A scan of the frequency range of the analyzer in the normal drive position shows (Figure 3)

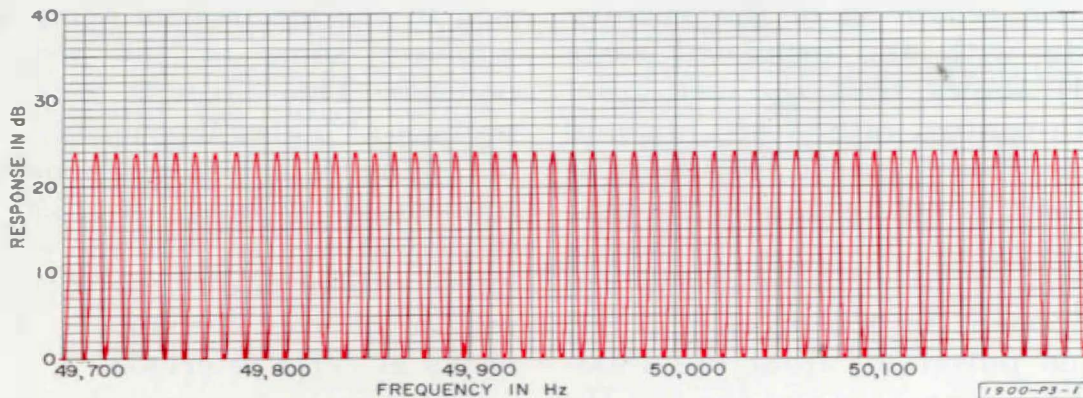

Figure 2. Section of a frequency spectrum in the vicinity of 50,000 Hz of a 30- μ s pulse repeated every 0.1 s. The expanded frequency scale is used to show the individual components every 10 Hz.

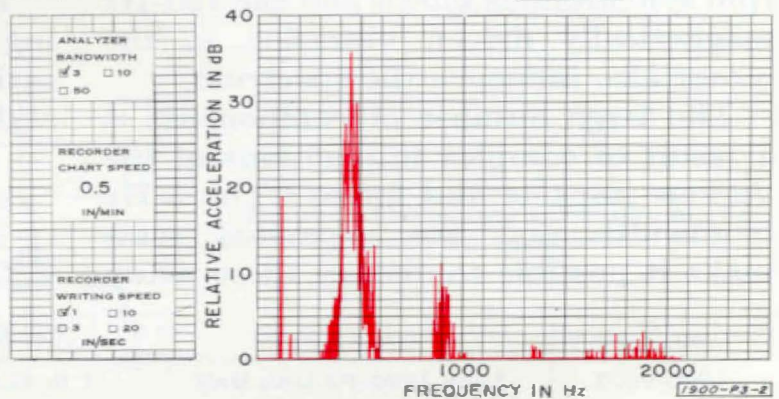

Figure 3. Analysis of the vibration of a frame holding a gear-belt drive. The frequency scale is sufficiently compressed to show the general character of the spectrum.

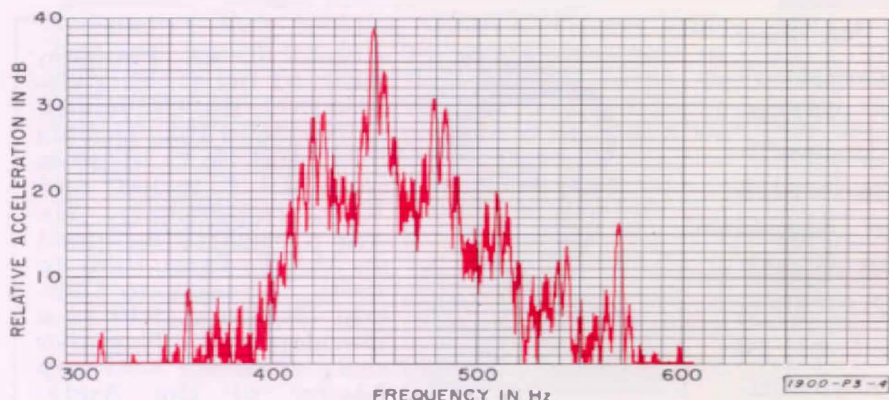

Figure 5. The expanded frequency scale is used here to show the components in the vicinity of 1350 Hz.

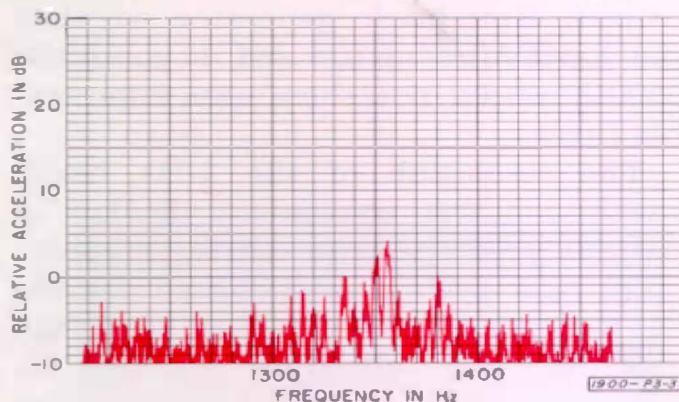

Figure 4. Analysis of the same vibration signal of Figure 3, but with the expanded frequency scale.

that the significant components of vibration are at 120 Hz, and in the vicinity of 450 Hz, 900 Hz, and 1350 Hz.

A detailed recording in the vicinity of 450 Hz with the expanded scale (Figure 4) shows that the belt-gear-drive tooth-contact rate of 450 impacts per second determines the frequency of the dominant component, and the gear belt with its speed of 5 r/s introduces a host of components spaced about the main component by multiples of 5 Hz. The torque pulsations from the 1800-rpm synchronous motor and the 120-Hz magnetically driven vibration in the motor also influence the spectrum.

The large number of components is a result of complex interactions of the various impacts and forces.² The 3-Hz bandwidth and the expanded scale make it possible to display these many

components and to determine their actual frequencies.

A significant amount of random motion in the mechanism being measured obscures some of the weaker components. This effect is even more important at higher frequencies. As shown in Figure 5, a few components in the immediate vicinity of 1350 Hz are displayed clearly, but the existence of many others is obviously probable by reason of the spacing of fluctuating peaks at 5-Hz intervals.

This new accessory makes the recording wave analyzer an even more versatile tool than before for the analysis of stable, complex signals.

— ARNOLD PETERSON

²L. S. Wirt, "An Amplitude Modulation Theory for Gear-Induced Vibrations," Chapter 17 of *Measurement Engineering* by P. K. Stein, Tempe, Arizona, 1962.

Catalog Number	Description	Net Wt	Ship Wt	Price in USA
1900-9603	Type 1900-P3 Link Unit	1 lb (0.5 kg)	4 lb (1.9 kg)	\$55.00

LOCATING SUBMARINE CABLES

Crossing San Francisco Bay are a great many submarine cables, which the Pacific Telephone and Telegraph Company uses for telephone services. An important factor in the maintenance of these cables is the ability to locate them accurately, not only in case of cable failure but also when contractors or government agencies are working in the area.

Some years ago, the Bay Area Chief Engineer's Department of Pacific Telephone developed a magnetic-induction system to locate submarine cables. A high-current oscillator sends an audio-frequency tone into one end of the cable with ground return. Receiving equipment is installed in a motor launch. The field produced by the cable current induces a voltage in a coil, which is amplified to operate a meter and a loudspeaker.

Recently a new receiver and transmitter were assembled to replace older and less reliable equipment. It was desirable to increase the range, which formerly was about 50 feet, and to package the receiver into one small transistorized unit. The new system is shown in Figures 1 and 2.

There are several problems associated with putting a tone on working telephone cables at the necessary high

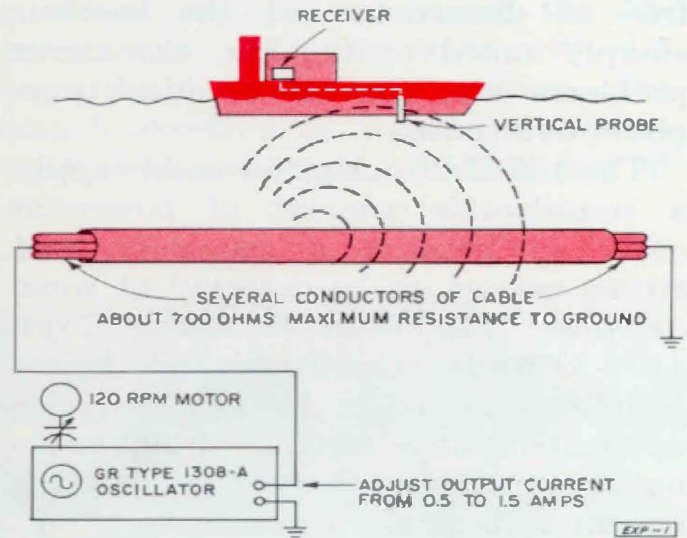

Figure 1. A signal is applied to the cable as shown, generating a magnetic field, which is detected by a probe and receiving equipment in the launch.

level and then in detecting it from a distance:

1. Crosstalk enters working pairs of the cable.
2. Harmonics interfere with carrier systems in the cable.
3. The receiving equipment picks up 60-Hz fields.
4. Harmonics of 60 Hz interfere with the received signal.
5. The sensitive receiver picks up noise from working circuits in cables.
6. Cable capacity shunts the transmitted tone to ground.

Tests have showed that a frequency

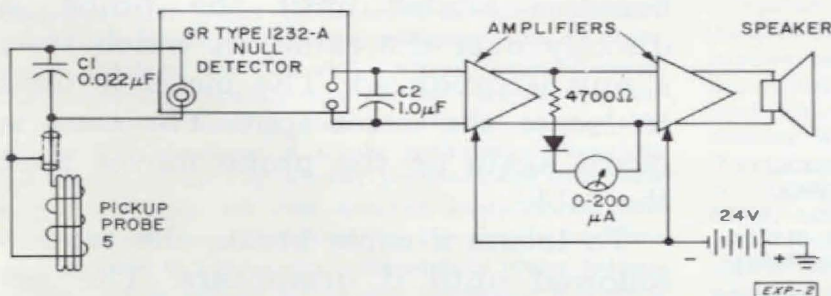

Figure 2. Elementary schematic of the receiving equipment.

of 150 Hz produces the best results. If the transmitted power is reasonably free of distortion and the receiver sharply tuned to 150 Hz, the above problems are, for all practical purposes, overcome.

The 150-Hz transmitter must supply a considerable amount of power in order to produce a magnetic field strong enough to be detected at some distance. The General Radio TYPE 1308-A Audio Oscillator and Power Amplifier proved to be ideal for this application. It is capable of 200 watts output and has meters to monitor the output voltage and current.

Figure 1 shows how the signal is applied to the cable. Several conductors of the cable are connected together at both ends, and the conductors are grounded at the far end. Maximum resistance is about 700 ohms. The 150-Hz power is applied between the multiplied conductors and ground, and the output current is adjusted to be between 0.5 to 1.5 amperes.

To ensure that the received signal is the one of interest and does not come from a power cable or some other

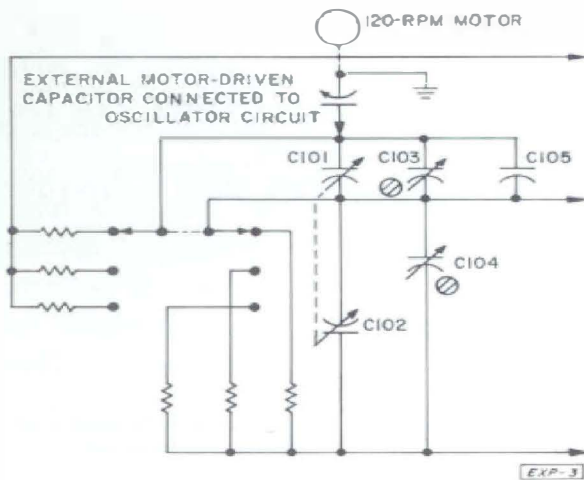

Figure 3. To produce a warble tone, a motor-driven capacitor is connected to the oscillator-tuned circuit.

NOTE

This interesting description of the use of electronic instruments to solve an important communications-system problem is published through the courtesy of the Pacific Telephone and Telegraph Company. Those interested in further details of the apparatus are referred to an article by L. W. Gunn and H. E. Bomar, entitled "Submarine Cable Detection," published in the December 1965 issue of *Electrical Construction and Maintenance*.

source, a distinctive tone is produced. A small variable capacitor connected to the oscillator circuit is driven by a 120-rpm clock-type synchronous motor to shift the frequency ± 2 Hz (see Figure 3).

The detecting probe consists of a 5-henry winding on a laminated iron core, tuned to 150 Hz with a shunt 0.22- μ F capacitor. It is mounted vertically near the bow and below the deck of the launch. The probe connects to the input of a General Radio TYPE 1232-A Tuned Amplifier and Null Detector, tuned to 150 Hz. The output drives a transistorized power amplifier and speaker (see Figure 2).

When driven at 150 Hz, a trumpet-type speaker was found to produce a marked third-harmonic output, which is easy to hear. As the launch approaches the cable, the operator hears the tone on the speaker and sees the relative level on the meter. The tone becomes louder until the probe is directly over the cable, at which time a null is produced. The meter is used to locate the exact spot. The tone is heard again as the probe moves past the cable.

To locate a cable break, the tone is followed until it disappears. The sea

water grounds the severed end of the cable to complete the circuit.

With 0.5 ampere of transmitter current and the cable in 80 to 100 feet of water, the receiver gives an excellent indication about 100 feet away from the cable. If additional conductors of the cable are available, they can be

multiplied to reduce the resistance. To increase the range, the current can be increased and still not exceed the 200 watts output. During tests with 1.5 amperes of transmitter current, the launch received a signal, somewhat weak, but usable, in over 200 feet of water.

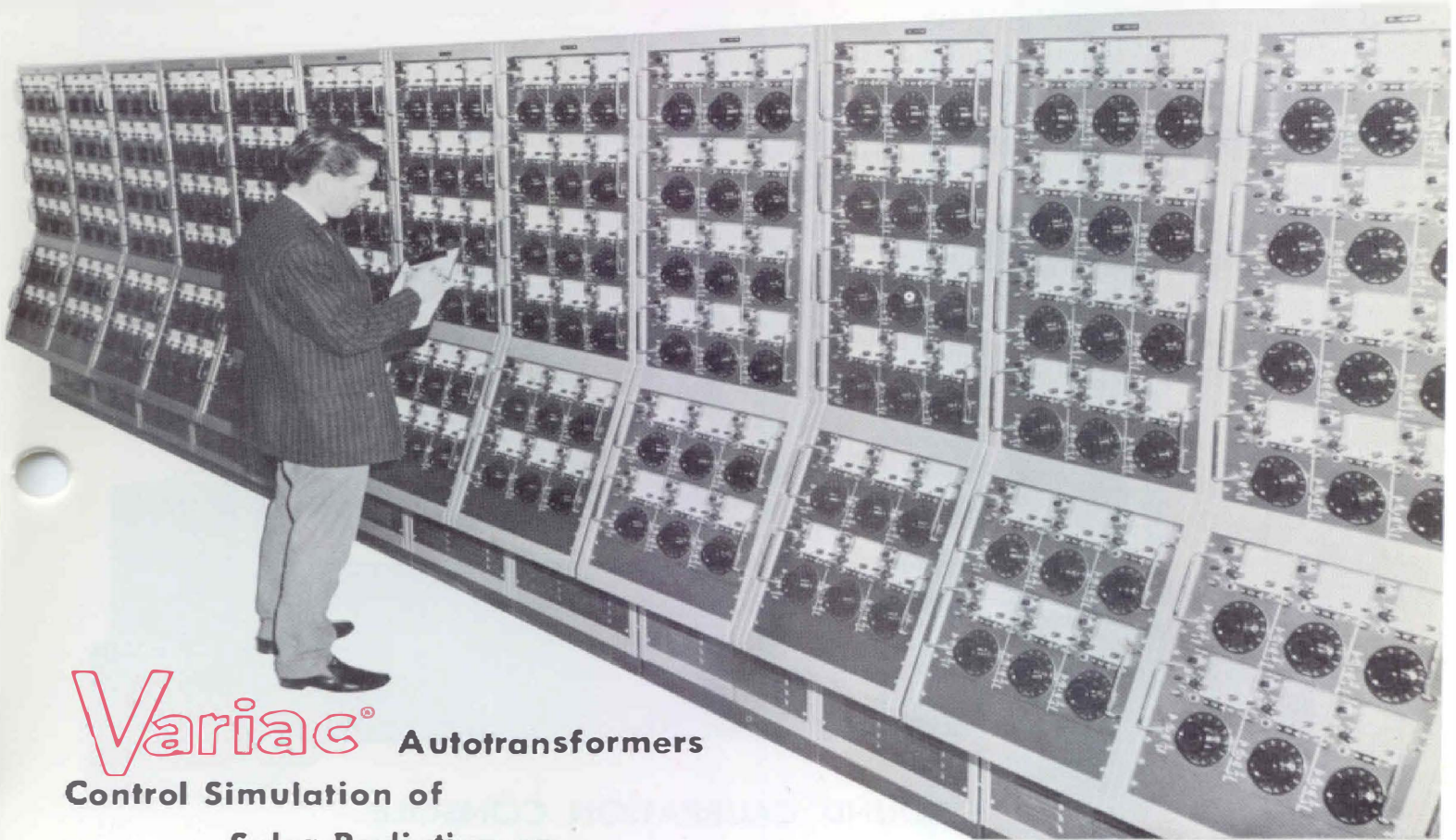

Variac® Autotransformers

Control Simulation of Solar Radiation on Lunar Excursion Module

*Photo courtesy of
Grumman Aircraft Engineering Corporation,
Bethpage, L. I., New York.*

Shown here are 12 of 14 bays in the thermal-test console designed by Grumman Aircraft Engineering Corporation to check out a Lunar Excursion Module mock-up under simulated thermal conditions of outer space. Each of the 252 motor-driven Variac® autotransformers accurately controls the voltage applied to a resistive heating element affixed to the skin of the LEM mock-up. A single pushbutton energizes the motors of all 252 Variac transformers, and their output voltages all rise simultaneously from zero to preset voltages established by the needle positions of ammeters in conjunction with optical meter relays. If further fine adjustment of any particular Variac is

required, it is done manually with the front-panel knob.

Variac autotransformers were selected for this installation for several important reasons. First, their proven reliability, simple design, and 1000% overload capability guarantee dependable operation and minimum maintenance. Second, a Variac does not destroy waveform purity by chopping or reshaping; if the input voltage is a sine wave, the output voltage is a sine wave. Consequently, no RFI is produced. Third, motor-driven Variac autotransformers can be programmed, which eliminates the need for manual adjustment of the initial voltage applied to each heating element.

GENERAL RADIO COMPANY
WEST CONCORD, MASSACHUSETTS 01781

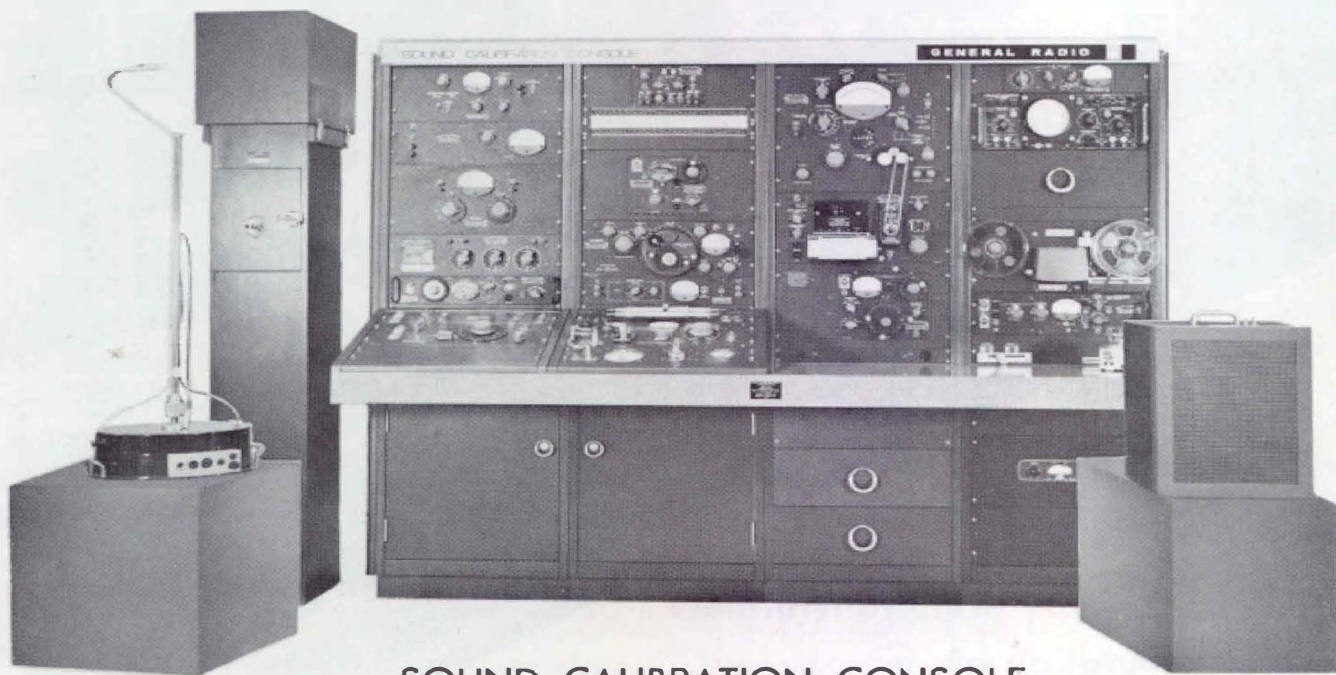

SOUND CALIBRATION CONSOLE

This Sound Calibration Console was supplied to the Calibration and Metrology Division, Newark Air Force Station, Newark, Ohio, for use as a laboratory standard of acoustical calibrations for the U. S. Air Force. Among the measurement capabilities of the console are the following:

Microphone Calibration—*Reciprocity Method*
Microphone Calibration—*Comparison Method*
Directional Calibration of Microphones
Frequency Response of Microphones
Frequency Analysis—*Narrow Band*
Frequency Analysis— $\frac{1}{2}$ -*Octave Band*
Frequency Analysis—*Octave Band*

Characteristics of Anechoic Rooms and Chambers
Reverberation Measurements—*Bands of Noise*
Reverberation Measurements—*Warble Tones*
Frequency Response of Amplifiers
Frequency Response of Tape Recorders
Tape Recording of Signals
Measurement and Analysis of Tape-Recorded Signals

► *Inquiries are invited for acoustic-measurement systems.*